

# **Resin Wicker 6 Piece Seating Set with Cushions(Chair & Ottoman) Assembly Instructions**

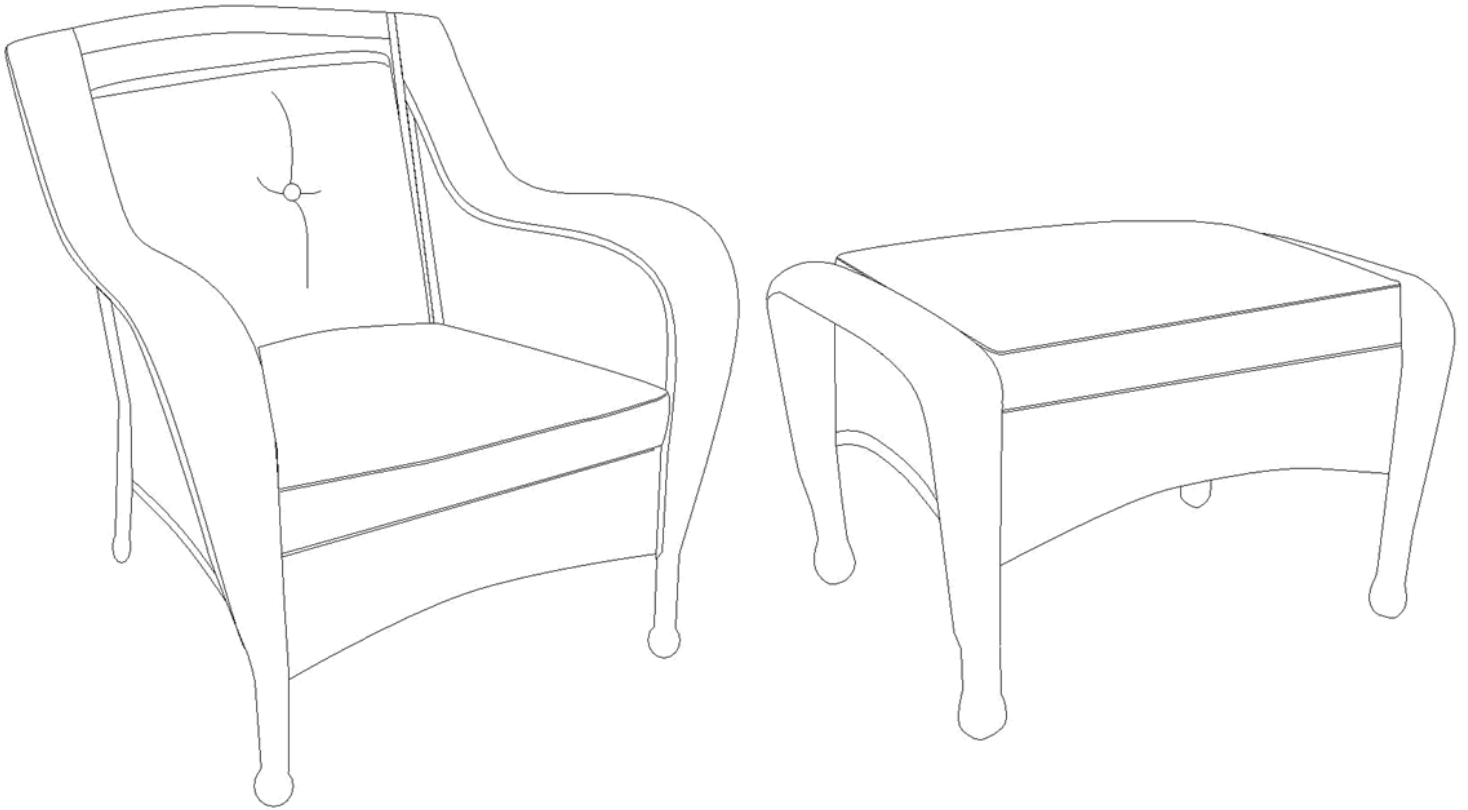

## **IMPORTANT:**









Please read all the instructions and warnings before assembling. In order to make the whole product adjust to the best, please install all the screws on the product before fully tighten!

## **WARNING:**

- \_ Keep all children and pets away from assembly area. Children and pets should be supervised when they are in the area of the product construction.
- \_ Keep assembly area at least 6 feet from any obstruction such as a fence, garage, house, overhanging branches, laundry line or electrical wires.
- \_ Some parts may contain sharp edges. When assembling and using this product, basic safety precautions should always be followed to reduce the risk of personal injury and damage to the product. Please read all instructions before assembly and use.
- \_ Check all bolts for tightness before use. **IMPORTANT** - check and tighten bolts often to keep them secure!
- \_ The chairs and ottomans are not to be used for standing purposes and will not function as a stool or step-ladder. Use on even surfaces only.
- \_ The chair use at weight of 250lbs. (113.6kgs).Improper use of this product or failure to use as directed may result in injury. Not intended for commercial use.

# Single Chair

## PARTS LIST:

NO.	Part	Qty	Image
A	Arm	2	
B	Chair Back	1	
C	Seat Apron	1	
D	Seat Panel	1	
E	Screw (ø6X14MM)	8	
F	Screw (ø6X25MM)	2	
G	Allen Wrench	1	
H	Seat Cushion	1	
I	Back Cushion	1	

Step 1: Secure the chair back (B) to the right arm (A) with screws (E,F) by using allen wrench (G). Do not fully tighten now.

Step 2: Fix the seat apron (C) with screws (E) by using allen wrench (G). Do not fully tighten now.

Step 3: Secure the left arm (A) with screws (E,F) by using allen wrench (G). Do not fully tighten now.

Step 4: Secure the seat panel (D) with screws (E). Fully tighten all the screws by using allen wrench (G).





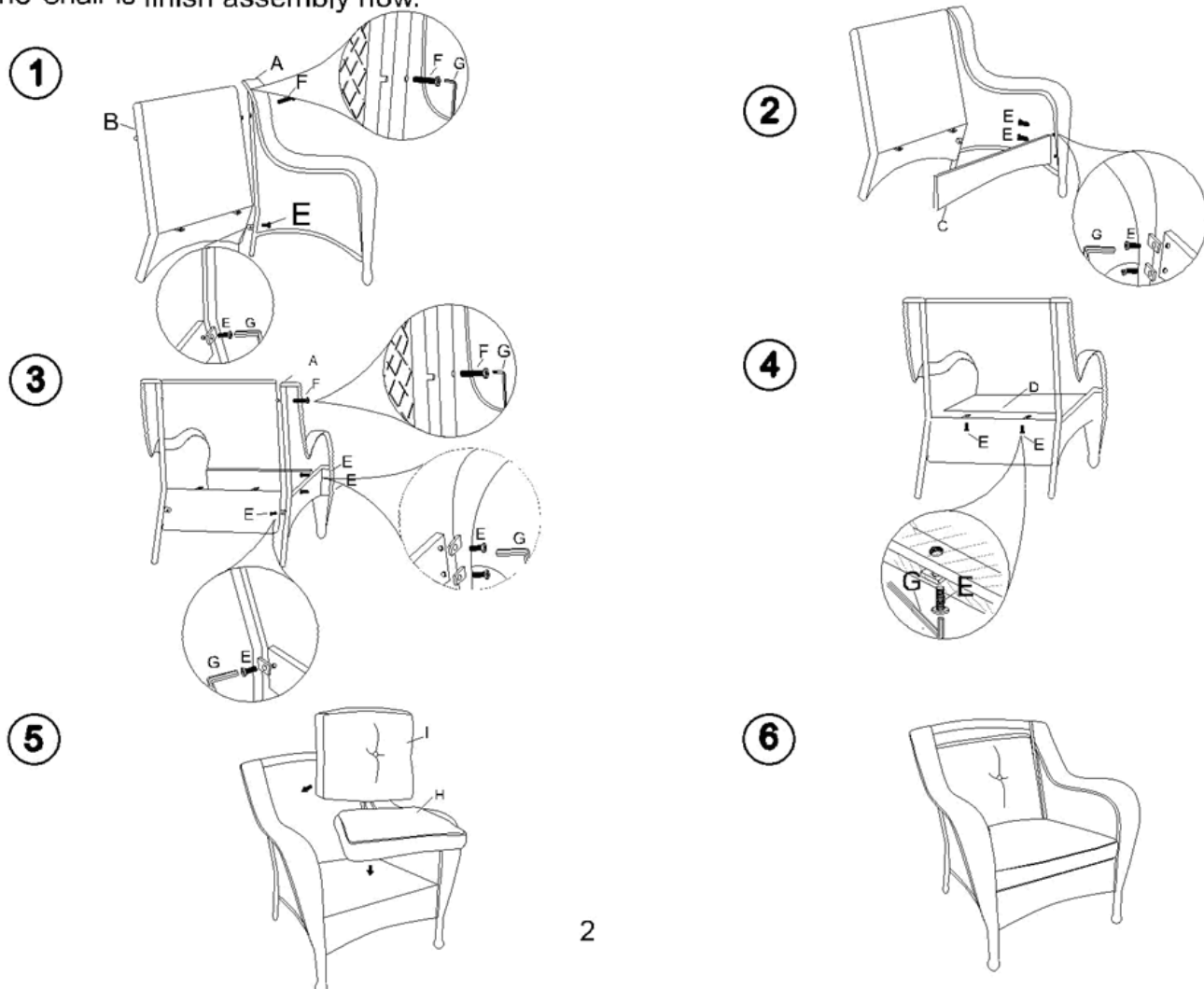

Step 5: Put the seat cushion (H) and back cushion (I) on the chair.

Step 6: The chair is finish assembly now.



# Ottoman

## PARTS LIST:

NO.	Part	Qty	Image
A	Leg	2	
B	Apron	2	
C	Seat Panel	1	
D	Cushion	1	
E	Screw (ø6X14MM)	8	
G	Allen Wrench(1pc)	1	

Step 1: Secure the front and back apron on the right leg with screws (E) by using allen wrench (G). Do not fully tighten now.

Step 2: Secure the left leg with screws (E). Fully tighten all the screws by using allen wrench (G).

Step 3: Fix the seat panel(C) on the top.

Step 4: Put the seat cushion (D) on the seat panel(C).

Step 5: The ottoman is ready to be used now.

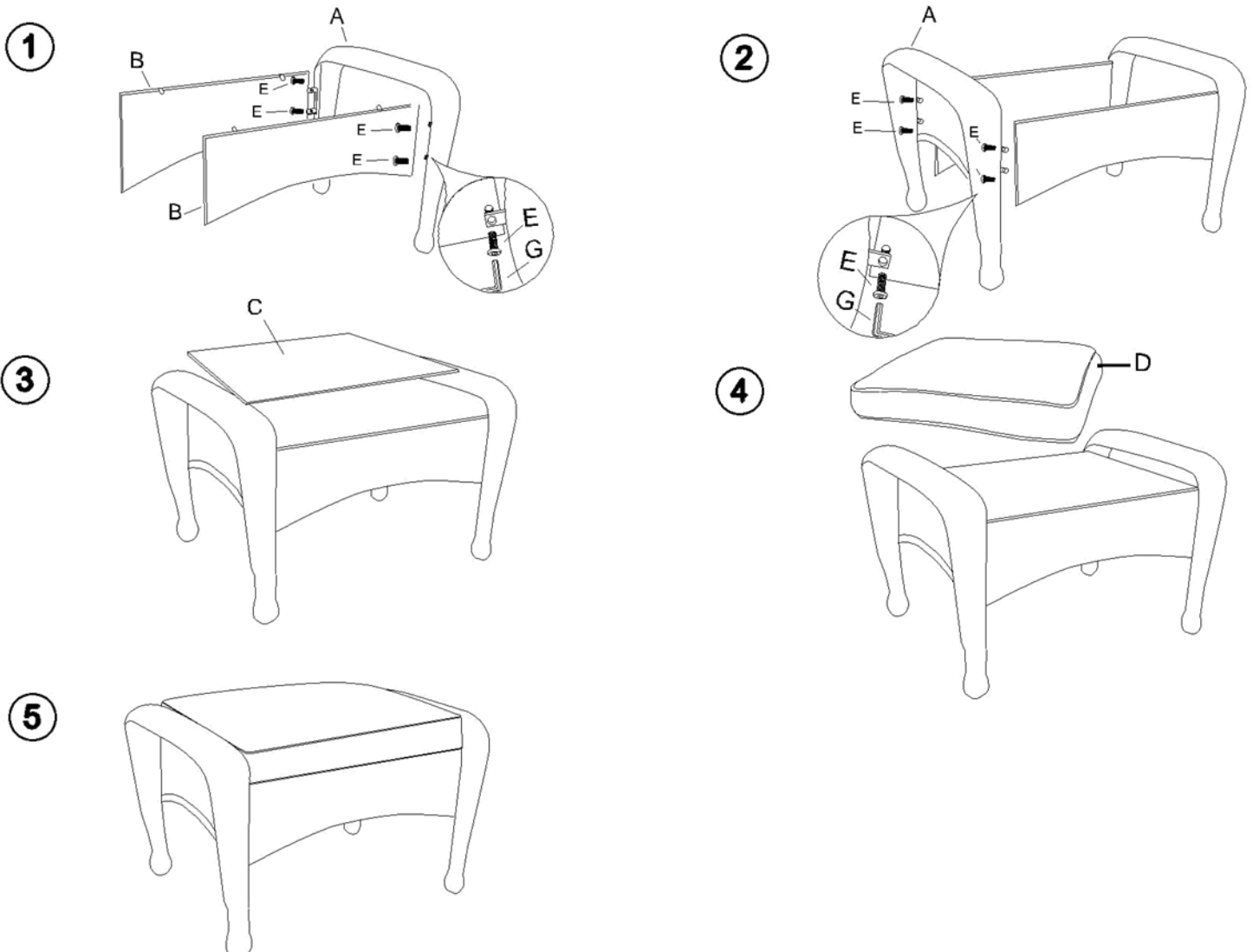

# **Resin Wicker 6 Piece Seating Set with Cushions(Coffee Table & Sofa) Assembly Instructions**

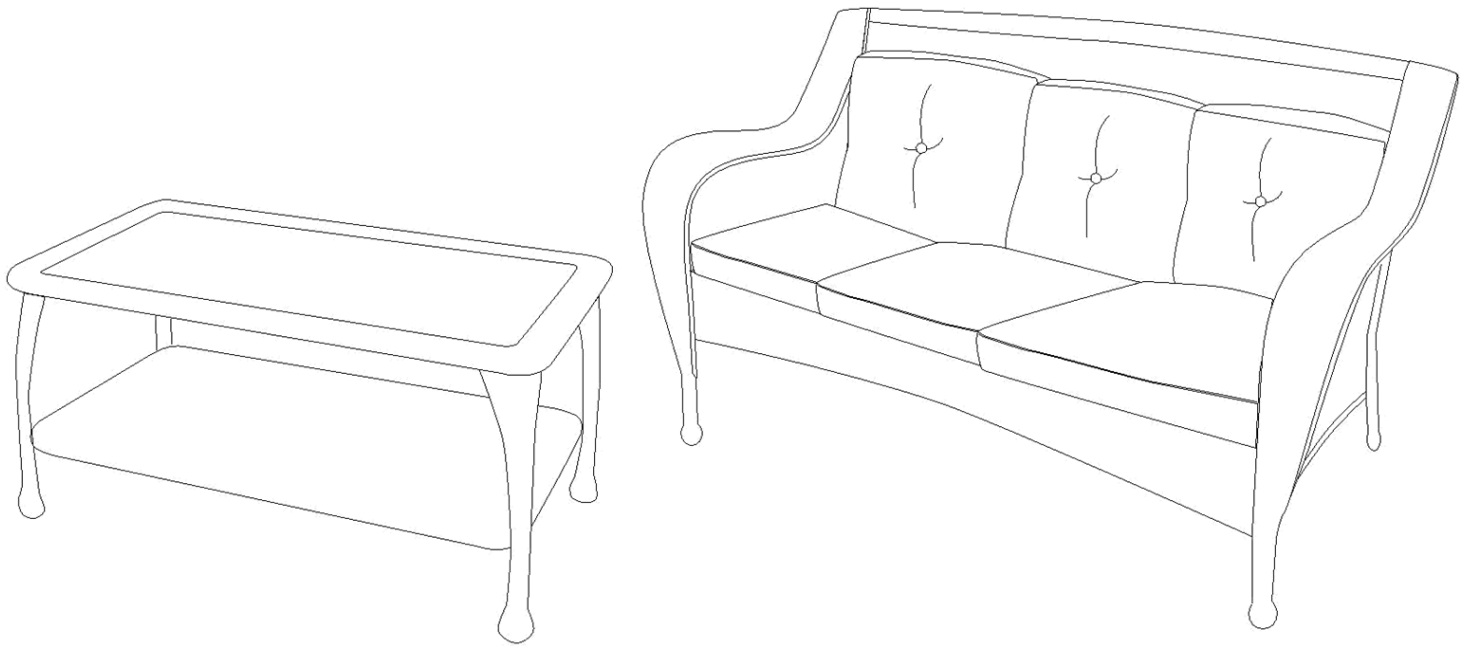

## **IMPORTANT:**





Please read all the instructions and warnings before assembling. In order to make the whole product adjust to the best, please install all the screws on the product before fully tighten!

## **WARNING:**

- \_ Keep all children and pets away from assembly area. Children and pets should be supervised when they are in the area of the product construction.
- \_ Keep assembly area at least 6 feet from any obstruction such as a fence, garage, house, overhanging branches, laundry line or electrical wires.
- \_ Some parts may contain sharp edges. When assembling and using this product, basic safety precautions should always be followed to reduce the risk of personal injury and damage to the product. Please read all instructions before assembly and use.
- \_ Check all bolts for tightness before use. **IMPORTANT** - check and tighten bolts often to keep them secure!
- \_ The sofa and coffee table are not to be used for standing purposes and will not function as a stool or step-ladder. Use on even surfaces only.
- \_ The sofa use at weight of 300lbs. (136.36kgs).Improper use of this product or failure to use as directed may result in injury. Not intended for commercial use.

# Coffee Table

## PARTS LIST:

NO.	Part	Qty	Image
A	Table Leg	4	
B	Table Top	1	
C	bottom shelf	1	
E	Screw (ø6X14MM)	12	
G	Allen Wrench	1	

Step 1: Assemble four legs(A) with screws (E) by using allen wrench (G). Do not fully tighten now.

Step 2: Secure bottom shelf with screws (E) . Fully tighten all the screws by using allen wrench (G).

Step 3: The coffee table is finish assembly.

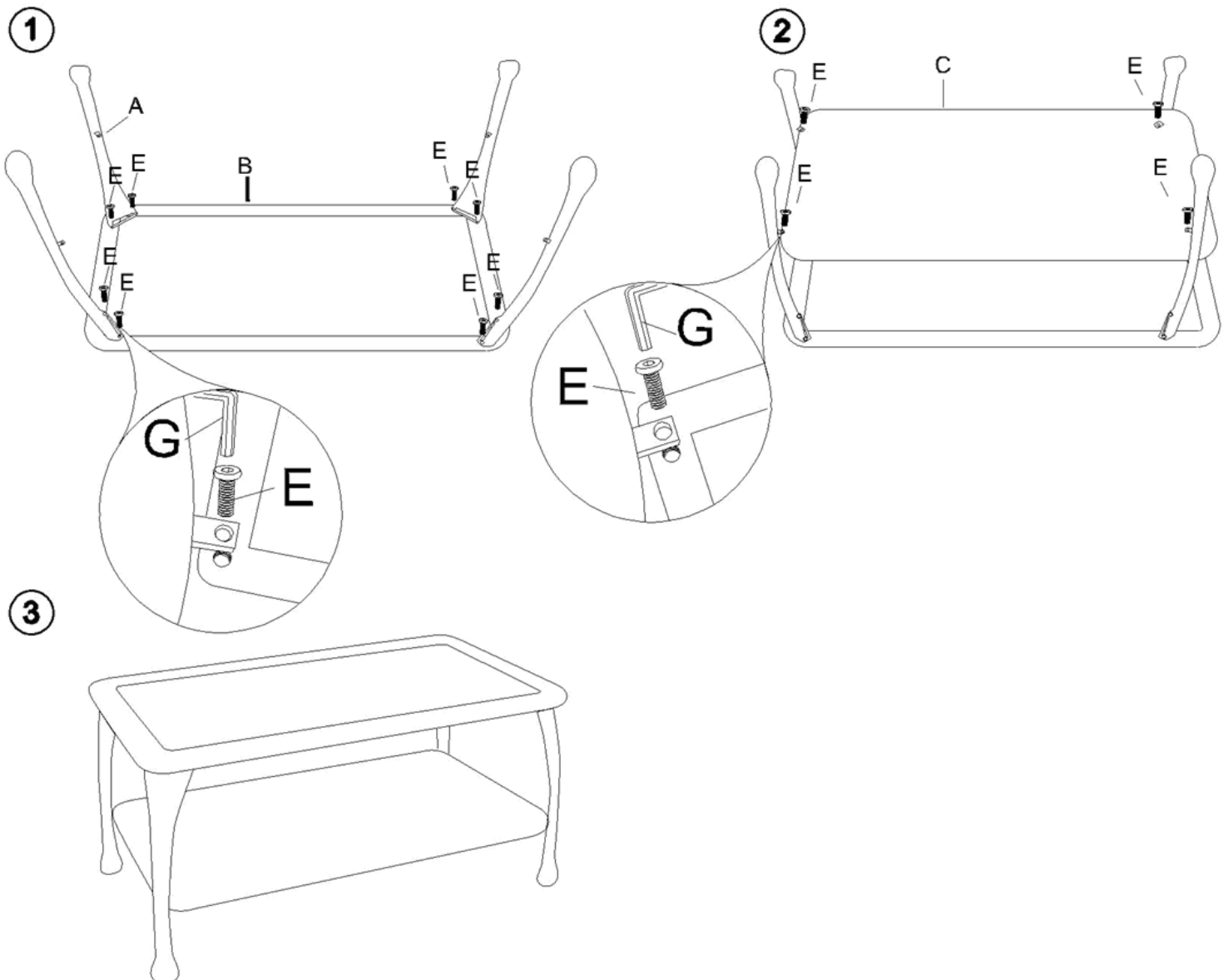

# Sofa

## PARTS LIST:

NO.	Part	Qty	Image
A	Arm	2	
B	Chair Back	1	
C	Seat Apron	1	
D	Seat Panel	1	
E	Screw (ø6X14MM)	10	
F	Screw (ø6X25MM)	2	
G	Allen Wrench	1	
H	Seat Cushion	3	
I	Back Cushion	3	

Step1: Secure the chair back (B) to the right arm (A) with screws (E.F) by using allen wrench (G). Do not fully tighten now.

Step2: Fix the seat apron (C) with screws (E) by using allen wrench (G). Do not fully tighten now.

Step 3: Secure the left arm (A) with screws(E.F)by using allen wrench (G). Do not fully tighten now.

Step 4: Secure the seat panel (D) with screws (E). Fully tighten all the screws by using allen wrench (G)

Step 5: Put the seat cushion (H) and back cushion (I) on the chair

Step 6: The chair is finish assembly now.

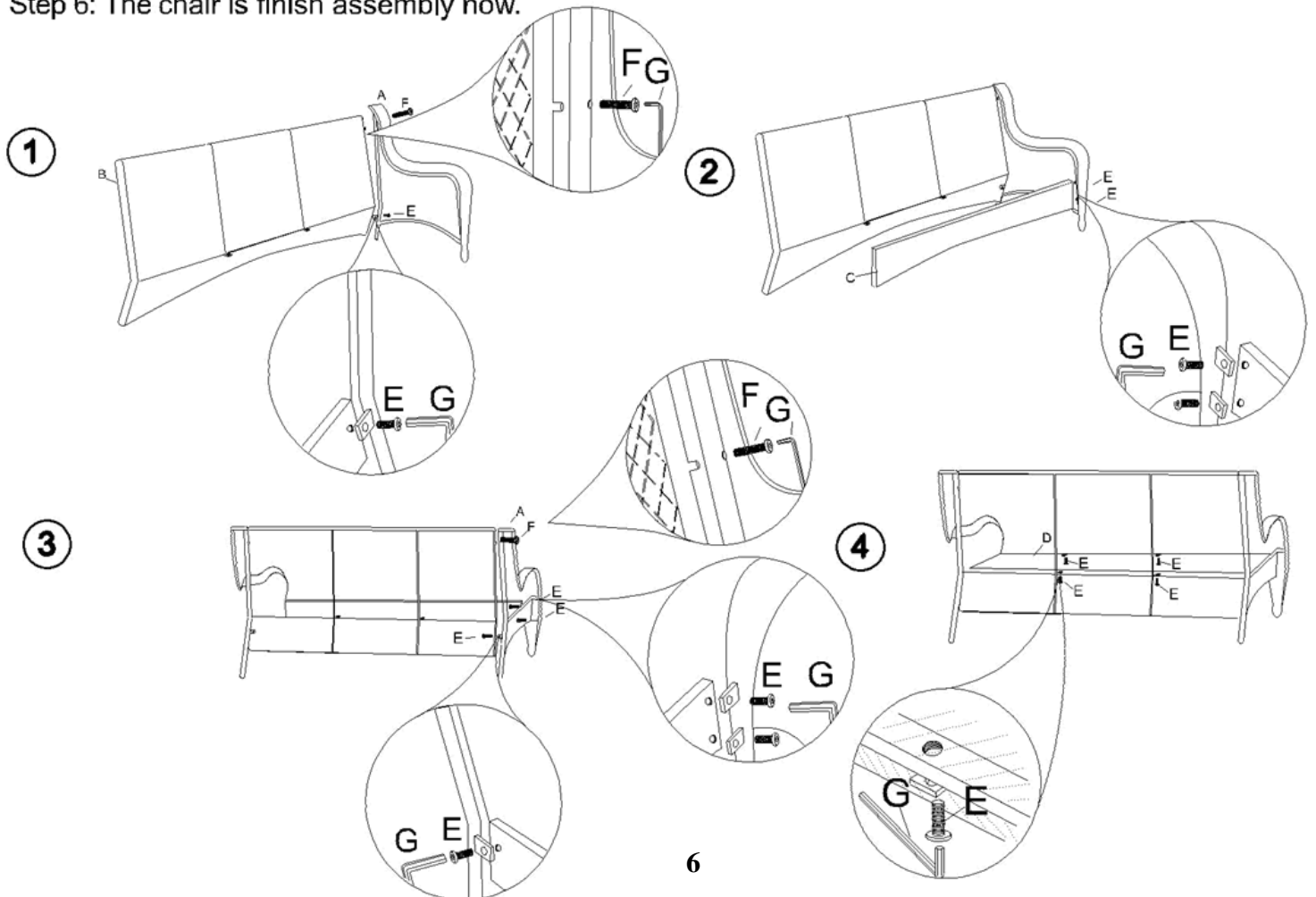

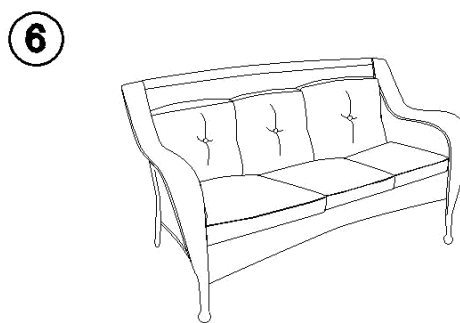
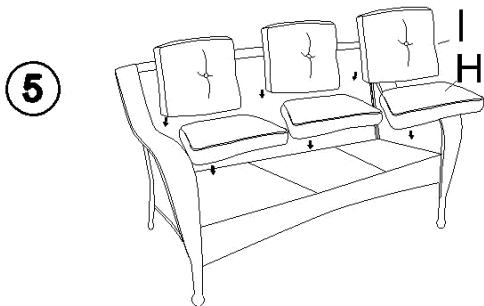

## Care & Maintenance:

### SPILLS:

Immediately wipe up the spill using a white damp cloth. Repeat process if necessary until stain is gone. Allow cushion to air dry.

### FABRIC CARE:

Hand wash cold, non-chlorine bleach when needed, lay flat to dry. Cool iron if necessary. Do not dry clean.

### RESIN WICKER PRODUCT CARE:

Before using, clean the product completely with a soft dry towel. When not in use, wipe free of any dirt or loose objects, wash with a mild solution of soap and water; rinse thoroughly and dry completely. Do not use strong detergent or abrasive cleaners. Over time nuts and bolts can loosen. Occasionally, check nuts and bolts on all chairs and table, re-tighten if necessary.