

Thanks for shopping with Jeco®

10 x10' Metal Gazebo with Double Roof and Netting

SKU# GZ2 / 15010253

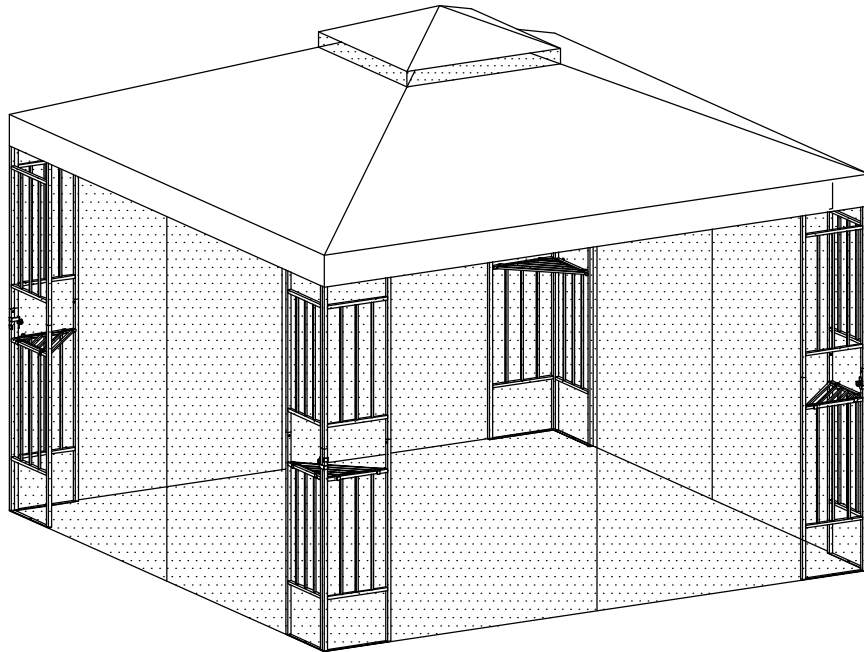

JECO

1-800-893-3006
Ontario, CA 91761











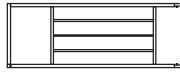
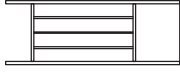

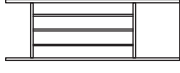

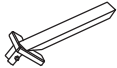
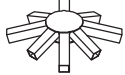
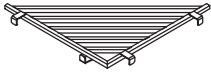

Made in China

If you have questions regarding this product, call
1-800-893-3006 Mon.-Fri. 9:00-5:00 PST
(California) and ask for our product specialists, or
e-mail: cs@jeco-inc.com

See many more products on the Internet!

www.jeco-inc.com

PARTS LIST

NO.	Description	Sketch	QTY
A	Upper Side Panel		4 PCS
B	Upper Side Panel		4 PCS
C	Upper Side Panel		4 PCS
D	Upper Side Panel		4 PCS
E	Middle Beam Tube		4 PCS
F	Beam Tube		8 PCS
G	Long Top Frame Beam 1		4 PCS
H	Long Top Frame Beam 2		4 PCS
I	Middle Top Beam 1		4 PCS
J	Middle Top Beam 2		4 PCS
K	Corner Connector		4 PCS
L	Top Connector		1 PC
M	Corner Shelf		4 PCS
N	Stake		12 PCS
O	Small Canopy		1 PC
P	Large Canopy		1 PC
Q	Mesh		4 PCS
R	Plastic Rings		32 PCS
S	Clamp		8 PCS
T	Guy Rope		4 PCS

To Assemble:

STEP 1

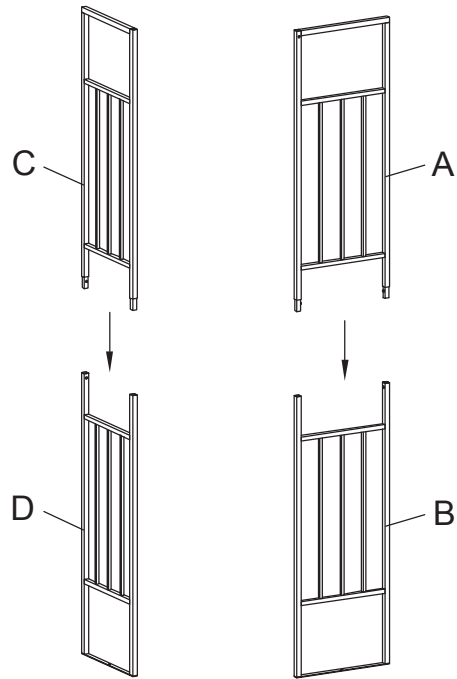

STEP 2

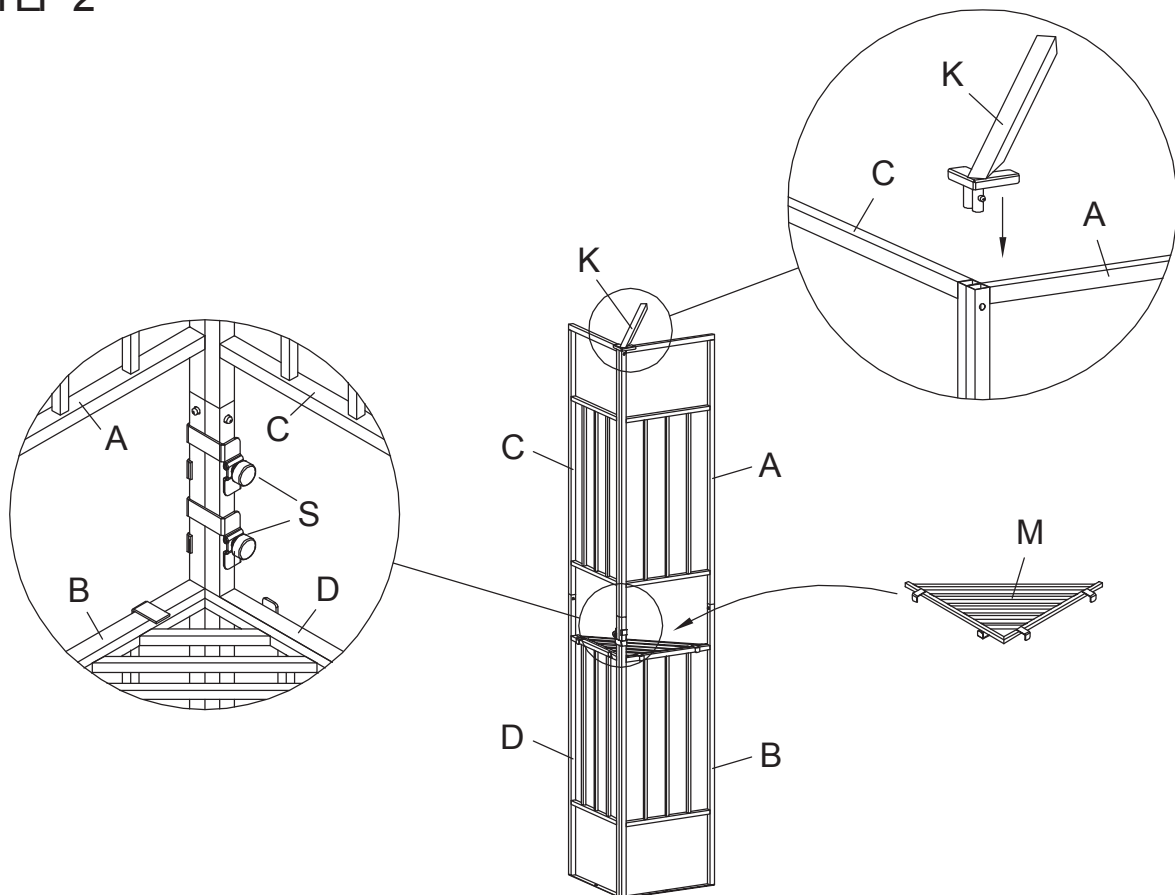

STEP 3

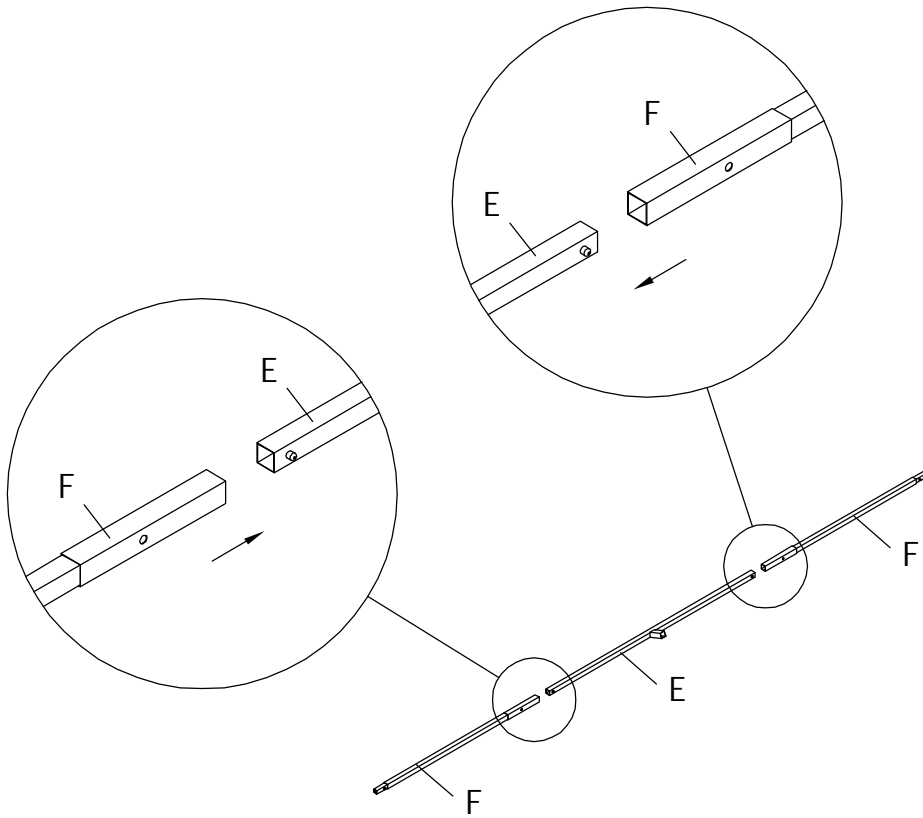

STEP 4

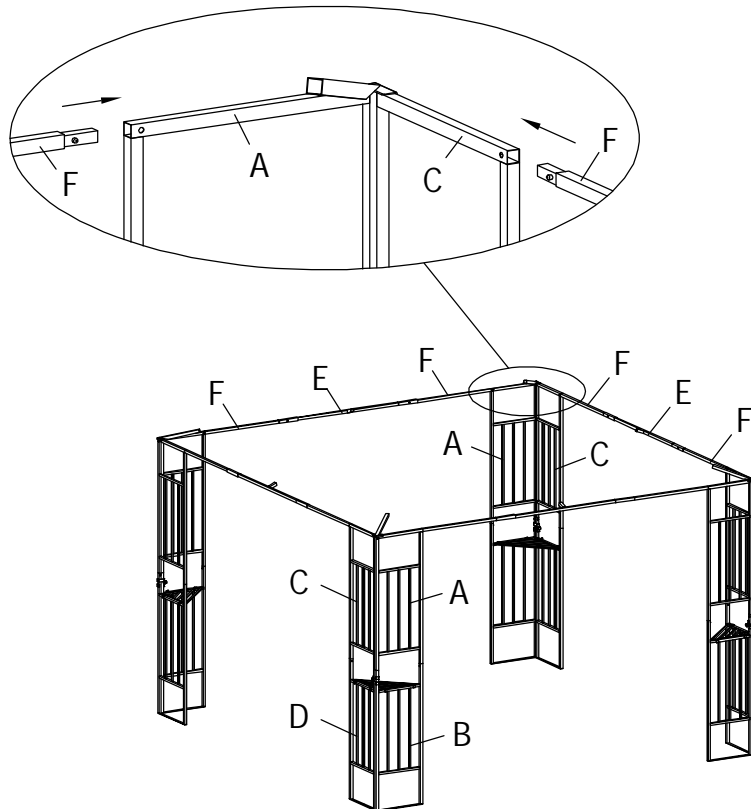

STEP 5

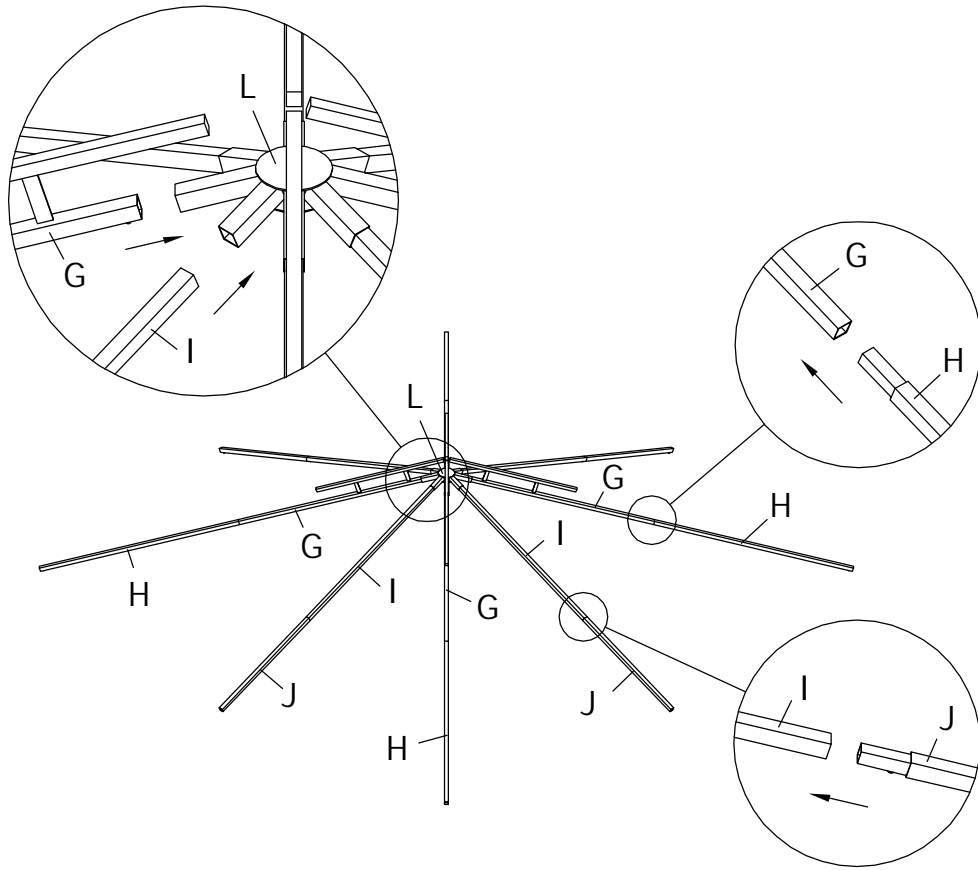

STEP 6

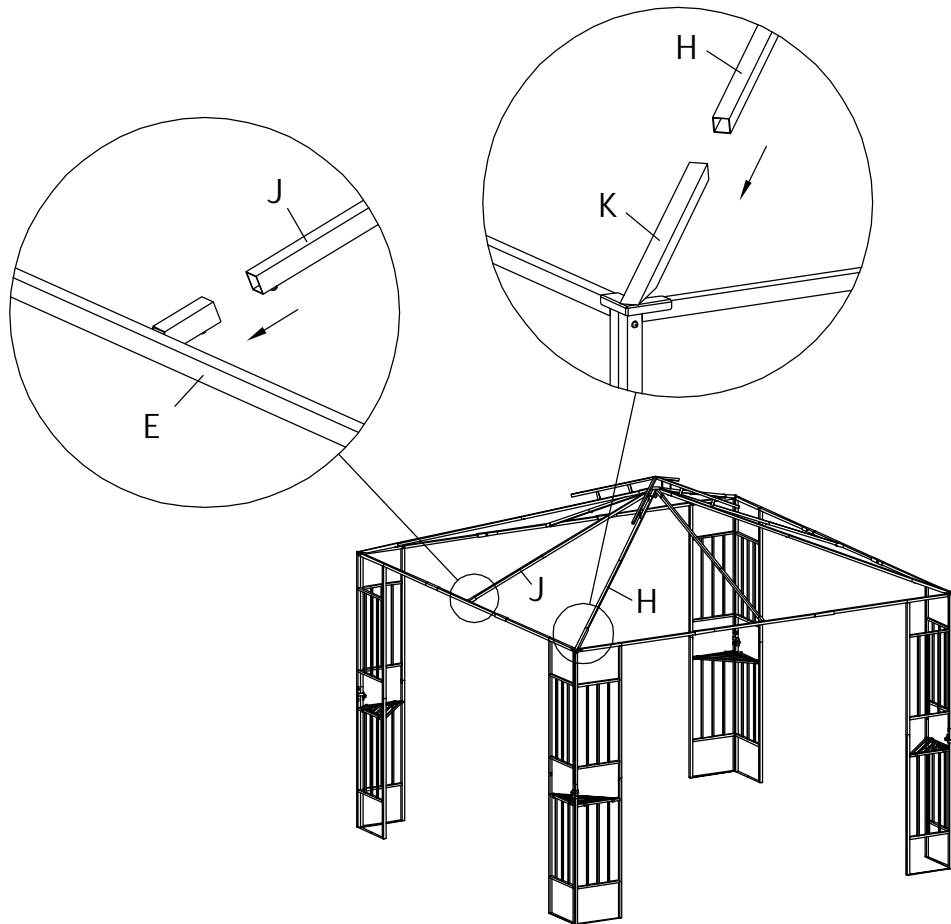

STEP 7

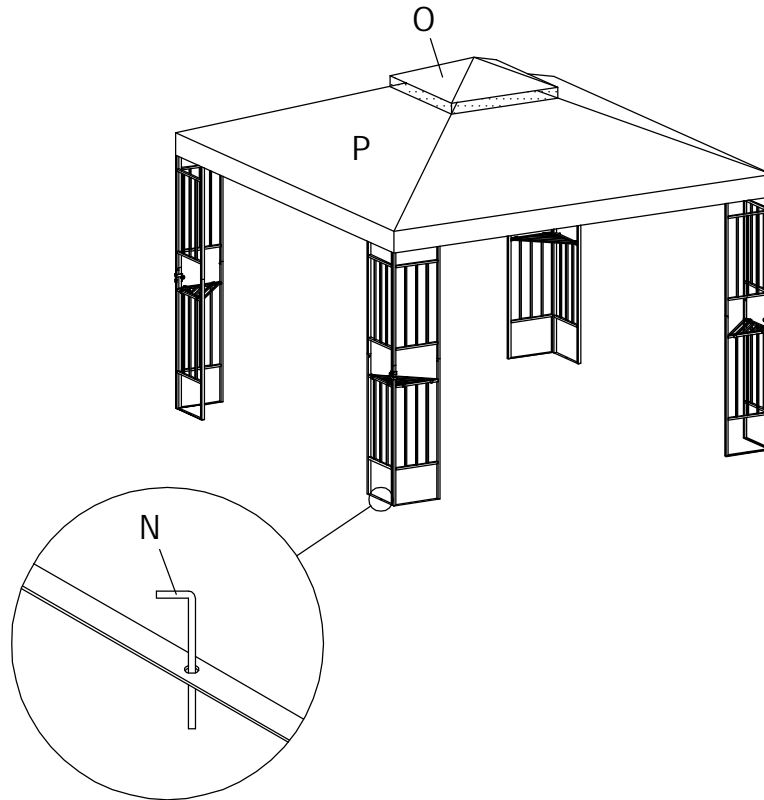

STEP 8

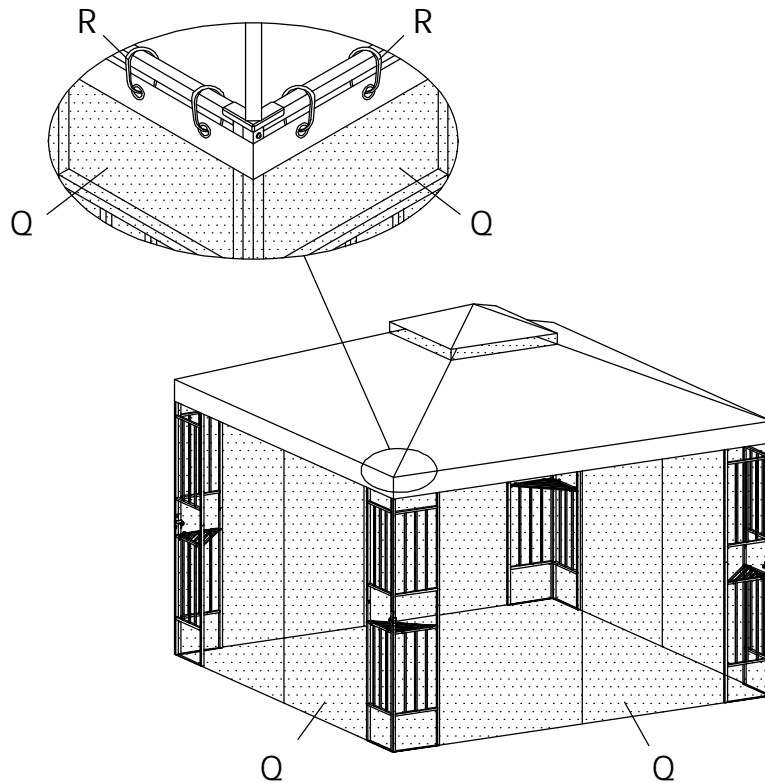

STEP 9

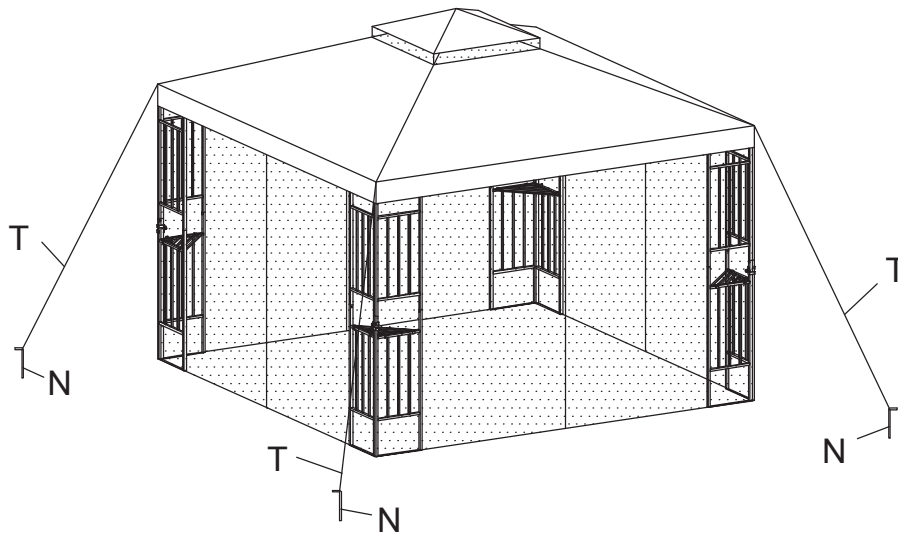

Note: This gazebo is meant to be used for decorative and sunshade purposes only and is not mean to withstand any elements of weather.

Please read these instructions carefully before starting assembly.

WARNING:

- 1) Do not cook underneath gazebo.
- 2) Do not ignite fireworks underneath gazebo.
- 3) Please keep the parts list, it could be useful to reorder some parts for service if necessary.